

### GENERAL DESCRIPTION

The BL9315 is a high-efficiency, DC-to-DC step-down switching regulators, capable of delivering up to 3.0A of output current. The BL9315 operates from an input voltage range of 2.5V to 5.5V and provides an output voltage from 0.6V to  $V_{IN}-0.3V$ , making the device BL9315 ideal for low voltage power conversions. Running at a fixed frequency of 1.5MHz allows the use of small external components, such as ceramic input and output caps, as well as small inductors, while still providing low output ripples. This low noise output along with its excellent efficiency achieved by the internal synchronous rectifier, making BL9315 an ideal green replacement for large power consuming linear regulators.

Internal soft-start control circuitry reduces inrush current. Short-circuit and thermal-overload protection improves design reliability.

The BL9315 is available in ESOP8 Package.

### FEATURES

- High Efficiency: Up to 95%
- Capable of Delivering 3.0A
- 1.5MHz Switching Frequency
- No External Schottky Diode Needed
- Low dropout 100% Duty operation
- Internal Compensation and Soft-Start
- Current Mode control
- 0.6V Reference for Low Output voltages
- Logic Control Shutdown ( $I_Q < 1\mu A$ )
- Over Voltage Protection
- Short Circuit Protection
- Thermal shutdown and UVLO
- Power good indicator
- Available in ESOP8 package

### APPLICATIONS

- Digital Cameras
- Set top boxes
- Wireless and DSL Modems
- USB supplied Devices in Notebooks
- Portable Devices

### TYPICAL APPLICATION CIRCUIT

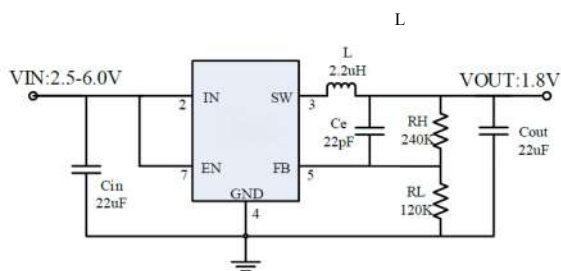

### PIN ASSIGNMENT

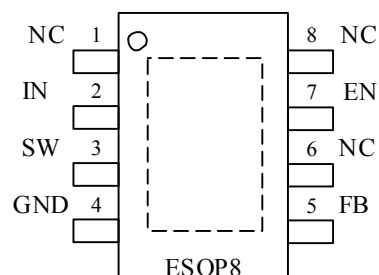

### ORDERING INFORMATION

PART NO	PACAKGE	TEMPERATURE	TAPE & REEL
BL9315	ESOP8	-40 ~ +85°C	3000/REEL

**PIN DESCRIPTION**

PIN No	SYMBOL	DESCRIPTION
1	NC	No Connection.
2	IN	Power Supply Input Pin. Must be closely decoupled to GND with at least 10uF ceramic cap.
3	SW	Inductor connection. Connect an inductor between SW and the regulator output.
4	GND	Ground
5	FB	Feedback input. Connect an external resistor divider from the output to FB and GND to set the output to a voltage between 0.6V and Vin
6	NC	No Connection.
7	EN	Enable pin for the IC. Drive the pin to high to enable the part, and low to disable
8	NC	No Connection.

**ABSOLUTE MAXIMUM RATINGS**(Note2)

Parameter		Value
Max Input Voltage		6.0V
Max Operating Junction Temperature(Tj)		150°C
Ambient Temperature(Ta)		-40°C – 85°C
Maximum Power Dissipation	ESOP8	1W
Storage Temperature(Ts)		-40°C - 150°C
Lead Temperature &Time		260°C, 10S

**Note2:** Absolute Maximum Ratings are threshold limit values that must not be exceeded even for an instant under any condition. Moreover, such values for any two items must not be reached simultaneously. Operation above these absolute maximum ratings may cause degradation or permanent damage to the device. These are stress ratings only and do not necessarily imply functional operation below these limits.

**RECOMMENDED OPERATING RANGE**

SYMBOL	ITEMS	VALUE	UNIT
V <sub>IN</sub>	V <sub>IN</sub> Supply Voltage	2.5 to 5.5	V
T <sub>OPT</sub>	Operating Temperature	-40 to +85	°C

**ELECTRICAL CHARACTERISTICS**
 $V_{IN}=5.0V$ ,  $L=2.2\mu H$ ,  $T_A=25^\circ C$ , unless otherwise specified.

Symbol	Parameter	Conditions	Min	Typ	Max	Unit
$V_{IN}$	Input Voltage Range		2.5		5.5	V
$V_{FB}$	Feedback Voltage		0.588	0.6	0.612	V
$I_{FB}$	Feedback Leakage current			0.1	0.4	$\mu A$
$I_Q$	Quiescent Current	Active, $V_{FB}=0.65V$		40		$\mu A$
$I_{SD}$	Shutdown Current	Shutdown			1	$\mu A$
$F_{SW}$	Switching Frequency			1.5		MHz
$R_{ONP}$	PMOSFET $R_{DSON}$			100		$m\Omega$
$R_{ONN}$	NMOSFET $R_{DSON}$			75		$m\Omega$
$V_{UVLO}$	UVLO Threshold				2.5	V
$V_{1HYS}$	UVLO Hysteresis			0.15		V
$I_{LIMIT}$	Peak Current Limit		5.0			A
$I_{SW}$	SW Leakage Current	$V_{IN}=5.5V$ , $V_{SW}=0$ or $5.5V$ , $V_{EN}=0V$			1	$\mu A$
$V_{OVP}$	Over Voltage Threshold			6.15		V
$V_{2HYS}$	OVP Hysteresis			0.3		V
$I_{EN}$	EN Leakage Current				1	$\mu A$
$I_{SOFT}$	Soft Start Time			350		$\mu S$
$V_{ENH}$	EN Input High Voltage		1.5			V
$V_{ENL}$	EN Input Low Voltage				0.4	V
$T_{SD}$	Thermal Shutdown			150		$^\circ C$
$T_{HSD}$	Hysteresis Thermal Shutdown			20		$^\circ C$
$R_{dis}$	Discharge resistor			150		$\Omega$

**TYPICAL OPERATING CHARACTERISTICS**

$C_{IN}=22\mu F$ ,  $C_{OUT}=22\mu F$ ,  $L=2.2\mu H$ ,  $C_e=22pF$ , Tested under  $T_A=25^\circ C$ , unless otherwise specified

Efficiency vs. Load Current

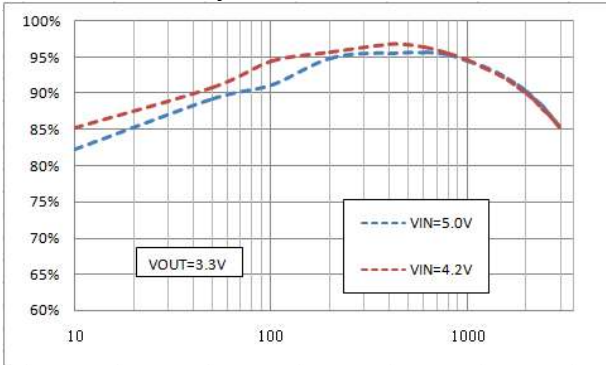

Efficiency vs. Load Current

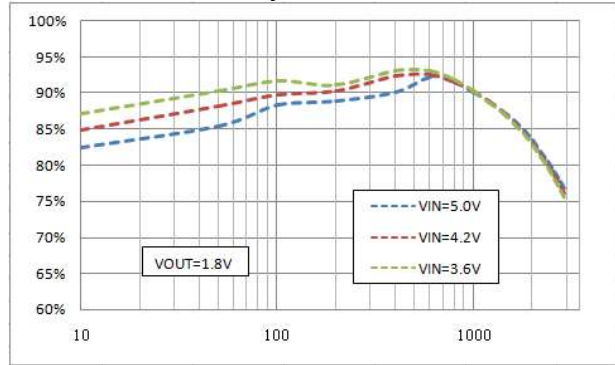

Efficiency vs. Load Current

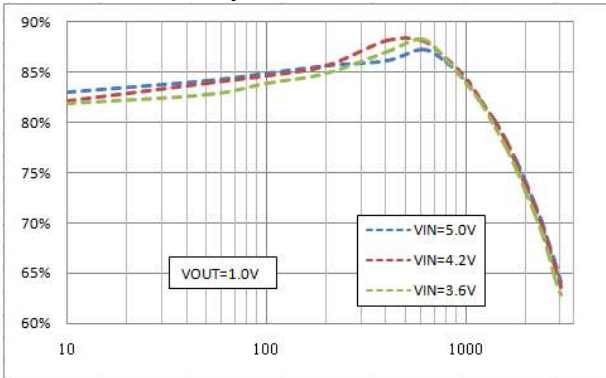

Output Voltage vs. Output Current

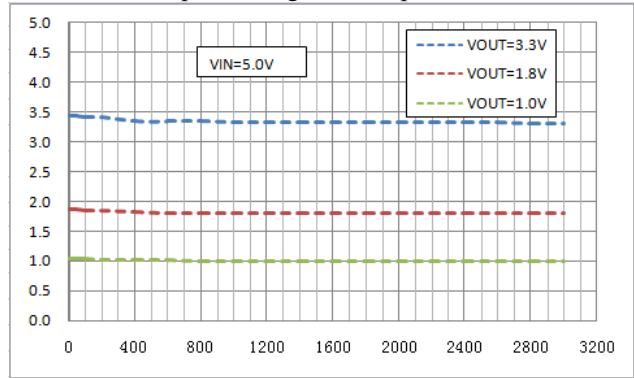

Operation Temperature vs. Output Voltage

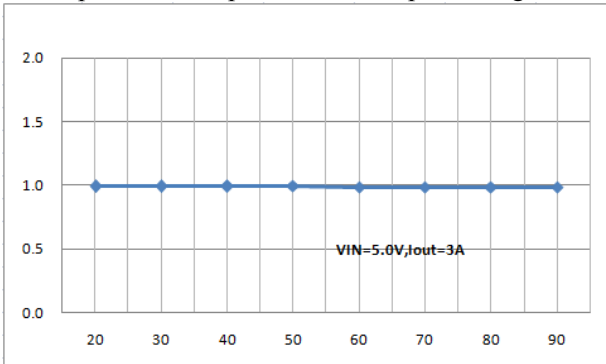

Input Voltage vs. Output Voltage

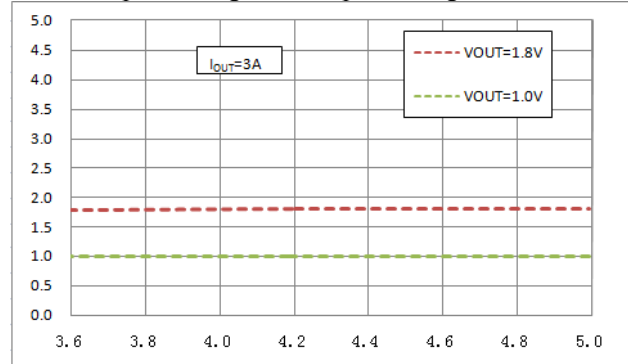

Start Up Waveform

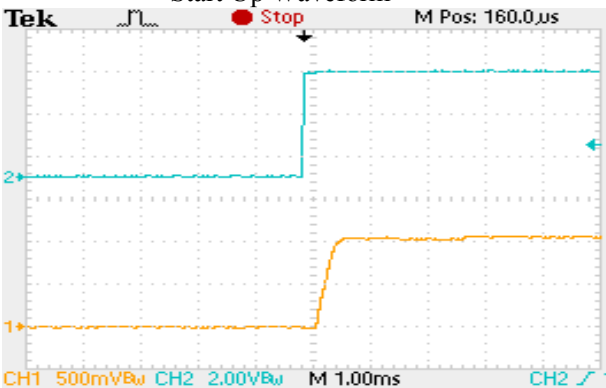

Shutdown Waveform

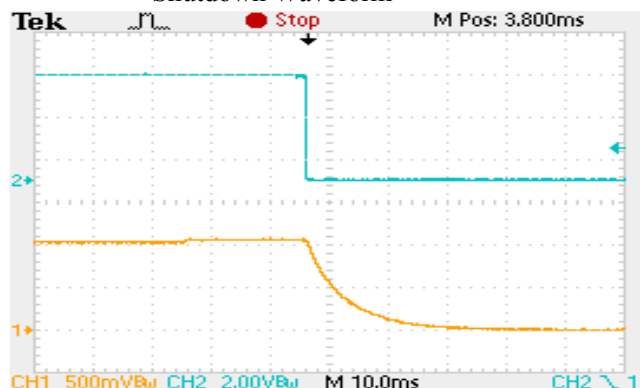

## OPERATION DESCRIPTION

The BL9315 high-efficiency switching regulator is a small, simple, DC-to-DC step-down converter capable of delivering up to 3.0A of output current. The device operates in pulse-width modulation (PWM) at 1.5MHz from a 2.5V to 5.5V input voltage and provides an output voltage from 0.6V to  $V_{IN}-0.3V$ , making the BL9315 ideal for on-board post-regulation applications. An internal synchronous rectifier improves efficiency and eliminates the typical Schottky free-wheeling diode. Using the on resistance of the internal high-side MOSFET to sense switching currents eliminates current-sense resistors, further improving efficiency and cost.

### Loop Operation

BL9315 uses a PWM current-mode control scheme. An open-loop comparator compares the integrated voltage-feedback signal against the sum of the amplified current-sense signal and the slope compensation ramp. At each rising edge of the internal clock, the internal high-side MOSFET turns on until the PWM comparator terminates the on cycle. During this on-time, current ramps up through the inductor, sourcing current to the output and storing energy in the inductor. The current mode feedback system regulates the peak inductor current as a function of the output voltage error signal. During the off cycle, the internal high-side P-channel MOSFET turns off, and the internal low-side N-channel MOSFET turns on. The inductor releases the stored energy as its current ramps down while still providing current to the output.

### Current Sense

An internal current-sense amplifier senses the current through the high-side MOSFET during on time and produces a proportional current signal, which is used to sum with the slope compensation signal. The summed signal then is compared with the error amplifier output by the PWM comparator to terminate the on cycle.

### Output OVP

If the output voltage exceeds 120% of the regulation level for more than 20 $\mu$ s, the BL9315 will turn off both power switches and turn on the discharge switch, entering over-voltage protection. It will remain in this state until IN and EN voltage is recycled.

### Short Protection

After the soft start is over, if the output voltage falls below 40% of the regulation level, the BL9315 will turn off both power switches, entering the short circuit protection. It will remain in this state until IN or EN voltage is recycled.

### Current Limit

There is a cycle-by-cycle current limit on the high-side MOSFET of 5.0A (min). When the current flowing out of SW exceeds this limit, the high-side MOSFET turns off and the synchronous rectifier turns on. BL9315 utilizes a frequency fold-back mode to prevent overheating during short-circuit output conditions. The device enters frequency fold-back mode when the FB voltage drops below 200mV, limiting the current to 5.0A and reducing power dissipation. Normal operation resumes upon removal of the short-circuit condition.

### Soft-start

BL9315 has an internal soft-start circuitry to reduce supply inrush current during startup conditions. When the device exits under-voltage lockout (UVLO), shutdown mode, or restarts following a thermal-overload event, the soft-start circuitry slowly ramps up current available at SW.

### UVLO and Thermal Shutdown

If IN drops below 2.5V, the UVLO circuit inhibits switching. Once IN rises above 2.5V, the UVLO clears, and the soft-start sequence activates. Thermal-overload protection limits total power dissipation in the device. When the junction temperature exceeds  $T_J = +150^{\circ}C$ , a thermal sensor forces the device into shutdown, allowing the die to cool. The thermal sensor turns the device on again after the junction temperature cools by  $15^{\circ}C$ , resulting in a pulsed output during continuous overload conditions. Following a thermal-shutdown condition, the soft-start sequence begins.

### Power Good

Power good flag is pulled down when AS6360 start-up and the FB pin voltage is still outside pre-set voltage window. During normal operation phase, when FB pin voltage drop under 90% or increase over 110%, power good flag is also pulled down.

## APPLICATION INFORMATION

### Setting Output Voltages

Output voltages are set by external resistors. The FB threshold voltage (VFB) is 0.6V.

$$R1 = R2 \cdot [(V_{OUT} / 0.6) - 1]$$

Set R2 to 100K, then R1 can be easily derived from the above equation.

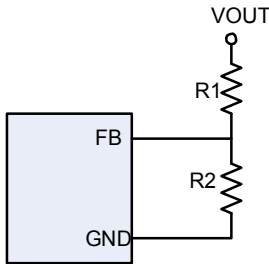

### Output Capacitor CO<sub>UT</sub>:

The output capacitor is selected to handle the output ripple noise requirements, both steady state ripple and transient requirements must be taken into consideration when selecting this capacitor. For the best performance, it is recommended to use X5R or better grade ceramic capacitor with 6.3V rating and greater than 22uF capacitance.

### Input Capacitor Selection

This ripple current through input capacitor is calculated as:

$$I_{CIN\_RMS} = I_{OUT} \times \sqrt{D(1-D)}$$

This formula has a maximum at  $V_{IN} = 2V_{OUT}$  condition, where  $I_{CIN\_RMS} = I_{OUT}/2$ . This simple worst-case condition is commonly used for the DC-DC design.

With the maximum load current at 2.5A, A typical X5R or better grade ceramic capacitor with 6.3V rating and

### Layout Consideration

Layout is critical to achieve clean and stable operation. The switching power stage requires particular attention. Follow these guidelines for good PC board layout:

- 1) Place decoupling capacitors as close to the IC as possible
- 2) Connect input and output capacitors to the same power ground node with a star ground configuration then to IC ground.
- 3) Keep the high-current paths as short and wide as possible. Keep the path of switching current (CIN to IN and CIN to GND) short. Avoid vias in the switching paths.
- 4) If possible, connect IN, SW, and GND separately to a large copper area to help cool the IC to further improve efficiency and long-term reliability.
- 5) Ensure all feedback connections are short and direct. Place the feedback resistors as close to the IC as possible.
- 6) Route high-speed switching nodes away from sensitive analog area.

more than 1pcs 22uF capacitor can handle this ripple current well. To minimize the potential noise problem, ceramics ceramic capacitor should really be placed close to IN and GND pins. Care should be taken to minimize the loop area formed by CIN and IN/GND pins.

### Output Capacitor CO<sub>UT</sub>:

There are several considerations in choosing this induction.

- 1) Choose the inductance to provide the desired ripple current. It is suggested to choose the ripple to be about 40% of maximum output current. The inductance is calculated as:

$$L = \frac{V_{OUT}(1 - V_{OUT}/V_{IN,MAX})}{F_{SW} \times I_{OUT,MAX} \times 40\%}$$

Where  $F_{SW}$  is the switching frequency and  $I_{OUT,MAX}$  is the maximum load current.

The BL9315 regulator IC is quite tolerant of different ripple current amplitude. Consequently, the final choice of inductance can be slightly off the calculation value without significantly impacting the performance.

- 2) The saturation current rating of the inductor must be selected to be greater than the peak inductor current under full load conditions.

$$I_{SAT,MIN} > I_{OUT,MAX} + \frac{V_{OUT}(1 - V_{OUT}/V_{IN,MAX})}{2 \cdot F_{SW} \cdot L}$$

- 3) The DCR of inductor and the ore loss at the switching frequency must be low enough to achieve the desired efficiency requirement. It is desirable to choose an inductor with  $DCR < 50m\Omega$  to achieve a good overall efficiency.

**PACKAGE OUTLINE**

**ESOP8**

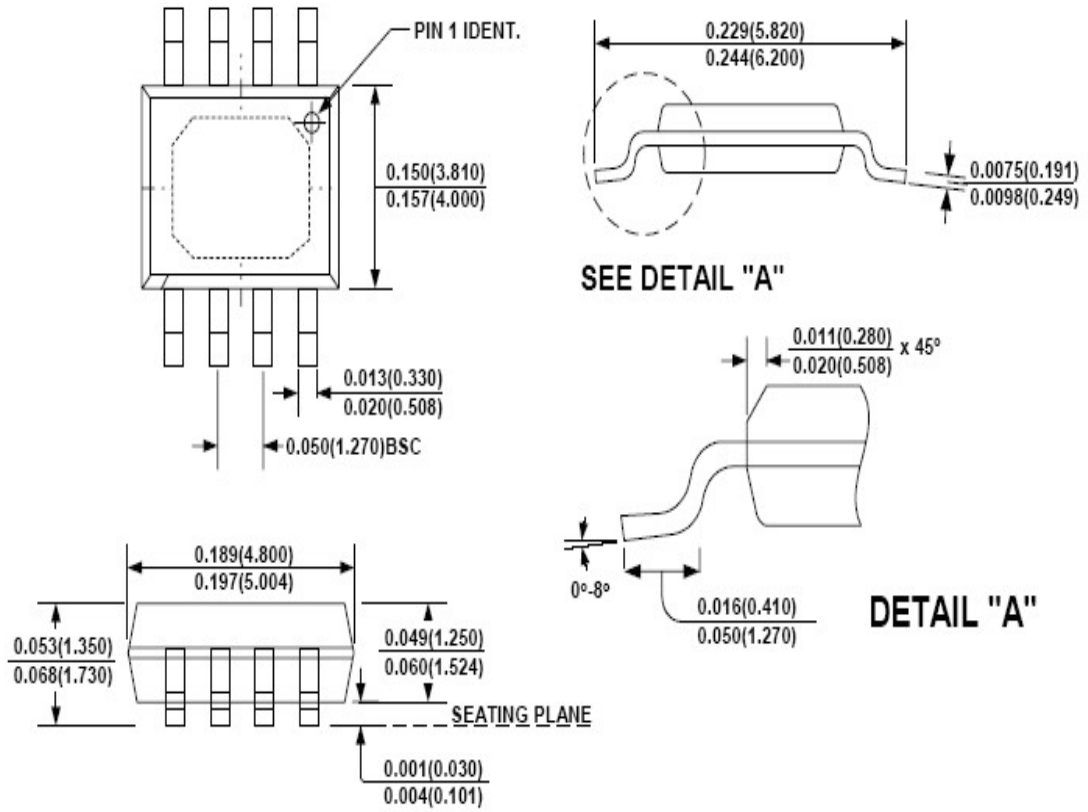

**NOTE:**

1) Control dimension is in inches. Dimension in bracket is millimeters.